

SWING radio fire detection system

FDCW241, FDOOT271, FDM273, FDM275, FDM275(F), FXS2061



SWING radio fire detection system

- Multihop mesh technology
- Full integration into the fire detection system FS20/FS720
- Simultaneous operation of wired and wireless peripheral devices
- High transmission reliability thanks to the use of independent communication paths – transmission occurs via at least two communication paths
- Large range thanks to radio transmission via up to two intermediate stations
- Up to 30 devices per gateway
- Up to 16 overlapping radio cells possible at each point
- Individual detector addressing for simple location identification
- Low power consumption, long battery service life

Properties

- Connected to the FDnet/C-NET, the radio gateway FDCW241 communicates with up to 30 radio devices, for example point detectors and manual call points. Each radio device has its own location address.
- The radio gateway forwards the signals received from the radio devices to the fire control panel via the detector line, and passes commands from the control panel to the detectors.
- Simultaneous operation of wired fire detectors on the FDnet/C-NET and wireless radio detectors on the radio gateway is ensured.
- The radio fire detection system works in two different frequency ranges for maximum reliability in terms of transmission and operation.

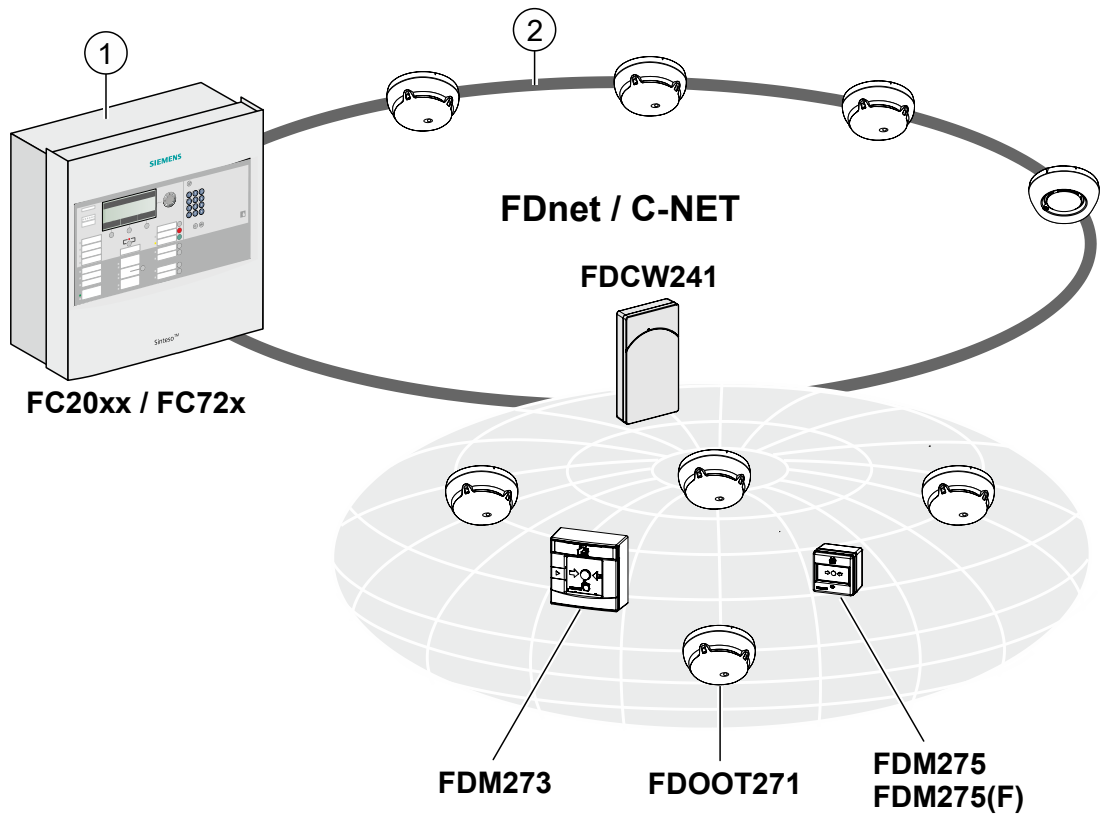

No.	Designation
1	Fire control panel
2	FDnet/C-NET detector line

The radio fire detection system is primarily used in places where there are restrictions on the laying of cables and pipelines for reasons of building technology, aesthetics, or for the protection of landmarked buildings.

The wireless coupling means that elaborate or visible cable installations are not required. The radio fire detection system is therefore particularly attractive to museums, churches, and so on.

It also offers the additional advantage that installation is possible without needing to interrupt operation.

When changing or extending the building use, the radio devices can be relocated easily without a great deal of effort or expense.

Typical areas of application

Rooms with important historical art features, e.g.:

- Museums
- Churches
- Libraries

Rooms that only permit short operational interruptions while installing the fire detection installation, e.g.:

- Hotel rooms
- Management offices
- Conference rooms

Extending existing systems with as little wiring effort and expense as possible, e.g.:

- Industrial rooms where the use is being changed
- Offices where the layout is being changed

Goal and purpose

In functional buildings, fire detection installations are optimized, planned, and installed to fit the requirements of the first user. Experience shows that even the requirements of the first user change over a short period of time: The company grows, and use and structures change, resulting in building modifications.

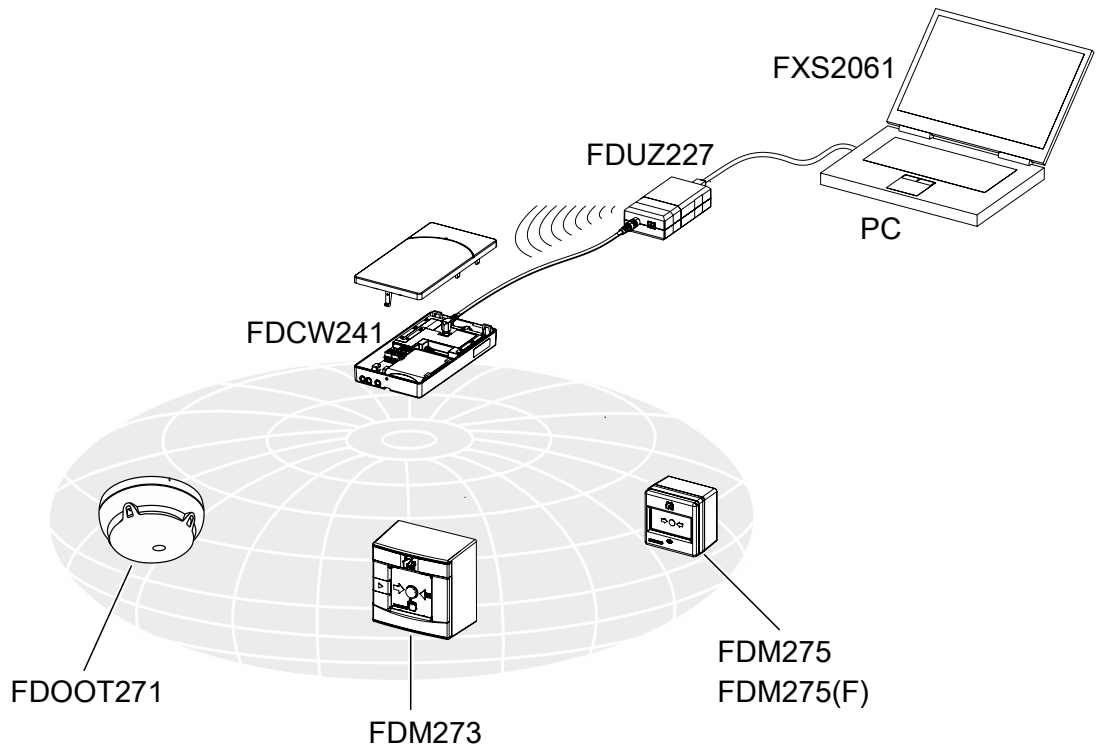

The FXS2061 SWING tool software can be used as an option for diagnostics and service, as well as for documentation. The MCL-USB adapter (radio) FDUZ227 must be connected to the PC in order to use the software.

Communication between the radio gateway FDCW241 and the FDUZ227 takes place via a cable connection or via radio. Communication between the FDUZ227 and the other radio devices only takes place via radio.

The radio devices are commissioned and maintained with the FXS2061 SWING tool software.

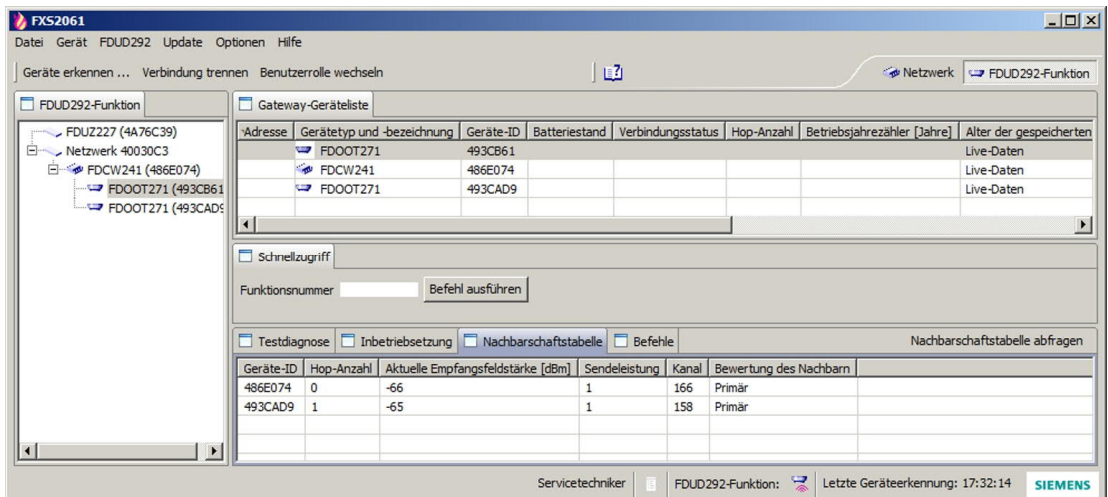

Overview of the program window FXS2061 SWING tool

Radio gateway FDCW241

Type	Designation	Order no.	Weight [kg]
FDCW241	Radio gateway	S54370-F11-A1	0.154
BAT3.6-10	Li-SOCI2 Batt.Pack 3,6 V, 10 Ah	S54370-Z11-A1	0.093

Accessories for the radio gateway FDCW241

Type	Designation	Order no.	Weight [kg]
FDCH221	Housing for input/output modules	S54312-F3-A1	0.282
FDUZ227	MCL-USB adapter (radio)	S54323-F106-A1	0.188
FXS2061 ¹⁾	SWING tool	–	–
DBZ1190-AB	0.5...2.5 mm ² (3-pin) connection terminal	BPZ:4942340001	0.001
FDCH271	Housing base for radio gateway	S54370-N45-A1	0.054
FDCH272	Housing cover for radio gateway	S54370-N46-A1	0.042

1) You can download the software from the Siemens Intranet.

Radio fire detector FDOOT271 and detector base FDB271

Type	Designation	Order no.	Weight [kg]
FDOOT271	Neural radio fire detector	S54313-F1-A1	0.132
FDB271	Detector base	S54319-F12-A1	0.038
BAT3.6-10	Li-SOCI2 batt. pack 3.6 V, 10 Ah	S54370-Z11-A1	0.093

Accessories for the detector base FDB271

Type	Designation	Order no.	Weight [kg]
FDBZ293	Detector locking device	A5Q00005035	0.001
FDBZ291	Designation plate	A5Q00002621	0.002
FDZ291	Detector dust cap	A5Q00004814	0.003

Radio manual call point FDM273

Type	Designation	Order no.	Weight [kg]
FDME273	Switching unit for FDM273	S54323-B108-A1	0.098
FDMH273-R	Red housing, with glass insert DMZ1196-AC and key DMZ1195	S54323-B109-A1	0.279
BAT3.6-10	Li-SOCI2 batt. pack 3.6 V, 10 Ah	S54370-Z11-A1	0.093

Accessories and replacement material for the radio manual call point FDM273

Type	Designation	Order no.	Weight [kg]
DMZ1197-AC	Protective cover	BPZ:5223550001	0.012
DMZ1196-AC	Glass insert	BPZ:4942050001	0.011
DMZ1195	Key	BPZ:4851910001	0.001

Radio manual call point FDM275

Type	Designation	Order no.	Weight [kg]
FDM275	Radio manual call point	S54323-F105-A1	0.216
BAT3.6-10	Li-SOCI2 batt. pack 3.6 V, 10 Ah	S54370-Z11-A1	0.093

Radio manual call point FDM275(F)

Type	Designation	Order no.	Weight [kg]
FDM275(F)	Radio manual call point	S54323-F105-A2	0.216
BAT3.6-10	Li-SOCI2 batt. pack 3.6 V, 10 Ah	S54370-Z11-A1	0.093

Accessories and replacement material for the radio manual call points FDM275 and FDM275(F)

Type	Designation	Order no.	Weight [kg]
FDMC295	Protective cover	A5Q00013440	0.036
FDMG295	Glass insert 'Neutral'	A5Q00013442	0.012
FDMG295-F	Glass insert 'France'	A5Q00013443	0.012
FDMP295	Plastic insert 'Neutral'	A5Q00013445	0.008
FDMP295-F	Plastic insert 'France'	A5Q00013446	0.008
FDMK295	Key	A5Q00013448	0.001



You will find information about the color options for radio gateway FDCW241, radio fire detector FDOOT271, and detector base FDB271 in data sheet 009409.

Description of the devices

Radio gateway FDCW241



- The radio gateway FDCW241 has an integrated line separator. The gateway has a complete send and receive unit and a microcontroller control unit for all functions that are required for radio transmission.
- Communication with the control panel and the supply takes place via the detector line (FDnet/C-NET).
- Signal processing and management of up to 30 radio devices
- The MCL-USB adapter (radio) FDUZ227 for the connection of the SWING tool FXS2061 enables information to be read for commissioning, maintenance, and error search.

Supply:

- Communication with the control panel and the supply takes place via the detector line (FDnet/C-NET).
- 3.6 V battery pack (AA lithium batteries) with a service life of at least six years

Neural radio fire detector FDOOT271



- Consistent response to a wide range of different fires
- Dynamic analysis of the sensor signal in the detector itself
- Built-in diagnosis algorithms with automatic selftest
- High degree of immunity to false alarms and environmental influences
- High-quality opto-electronic sensor system
- Automatic compensation for soiling
- Radio fire detector can be mounted anywhere in a radio cell
- Detector can be inserted and removed using the detector exchanger tool up to a height of 8 meters

Functions:

- **4 danger levels:**
 - Enable activation of differentiated measures and an early warning in the case of incorrect application.
- **Selftest:**
 - The detector performs a comprehensive selftest periodically or on command.
- **Signal processing with ASAtechnology ('Advanced Signal Analysis')**
 - Special calculation procedures in the detector processor enable optimum signal processing defined for the detector. This ensures excellent interference immunity and operational reliability.
- **Measurement compensation:**
 - Ensures the detector demonstrates a virtually identical level of sensitivity throughout the operating period.
- The integrated alarm indicator shows the alarm on site.

Supply:

- The neural fire detector FDOOT271 is supplied with power by a battery pack (AA lithium batteries). The batteries must not be inserted until the time of commissioning.

Detector base FDB271



- Base for radio fire detector FDOOT271.
- Once the battery has been connected, the detector must not be inserted into the base until the time of commissioning.

Radio manual call point FDM273

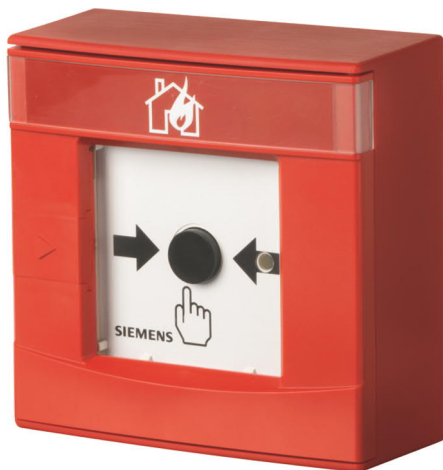

- Radio manual call point can be mounted anywhere in a radio cell
- The radio manual call point consists of a housing and a switching unit including radio electronics and dual-band antenna
- Indirect alarm activation by smashing the glass insert and pressing the alarm button
- A protective cover (accessories) protects the manual call point against the glass being broken accidentally

Supply:

- The radio manual call point FDM273 is supplied with power by a battery pack (AA lithium batteries). The batteries must not be inserted into the switching unit until the time of commissioning.

Radio manual call points FDM275 and FDM275(F)



- The radio manual call points FDM275 and FDM275(F) can be mounted anywhere in a radio cell.
- The radio manual call points consist of a back box, a switching unit, and a battery pack.
- The alarm is activated directly by pressing the plastic insert.
- A key is used to reset the radio manual call point and restore readiness for operation.
- A protective cover (accessories) protects the manual call point against accidental activation.

Supply:

- The radio manual call points FDM275 and FDM275(F) are supplied with power by a battery pack (AA lithium batteries). The batteries must not be inserted into the switching unit until the time of commissioning.

Battery pack BAT3.6-10



- For supplying radio devices and the radio gateway with power FDCW241.
- Lithium batteries BAT3.6-10 LI-SOCI2 battery pack 3.6 V, 10 Ah.
- Batteries with cable and connector with protection against polarity reversal
- Inscription field for commissioning date
- Service life of at least three years in normal operation
- Battery monitoring to ensure remaining life of at least six months by connecting a backup battery.
- Compatible with the following components:
 - Radio gateway FDCW241.
 - Radio fire detector FDOOT271.
 - Radio manual call point FDM273.
 - Radio manual call point FDM275, FDM275(F).

Document ID	Name
008331	List of compatibility (for 'Sinteso™' product line)
A6V10229261	List of compatibility (for 'Cerberus™ PRO' product line)
008164	Equipment overview Sinteso™ Detector system FD20
A6V10227631	Planning Radio fire detection system SWING
A6V10227639	Technical manual Radio gateway FDCW241
A6V10227635	Technical Manual Radio fire detector FDOOT271
A6V10347733	Technical Manual Radio manual call point FDM273
A6V10401120	Technical Manual Radio manual call point FDM275, FDM275(F)
A6V10227643	User Guide SWING-Tool FXS2061
A6V10347735	Installation MCL-USB adapter (radio) FDUZ227
009409	Data sheet Colored detectors, bases and base attachment FDO., FDOOT..., FDT..., FDB...

Related documents such as the environmental declarations, CE declarations, etc., can be downloaded from the following Internet address:

<https://siemens.com/bt/download>

Operation

Mesh network

- A mesh network is a wireless network which manages itself. Each network node is connected to one or more other nodes. Information is passed from node to node until it reaches its destination.
- Since the SWING mesh network is generally able to rectify faults automatically, it is very reliable: If a node or a connection is blocked or fails, the network can work around the problem. Data is diverted and the network continues to operate.
- Bidirectional data transmission in the frequency range 868...870 MHz (SRD) and 433...435 MHz
- The SRD band (Short Range Device) is a reserved frequency band with defined rules governing its use. The SRD band is free from amateur users.
- Radio:
 - Encrypted information transmission
 - Monitoring of connection/system integrity
- Advantages: Most secure type of network. If a device or a connection fails, data can be diverted so that communication can continue.

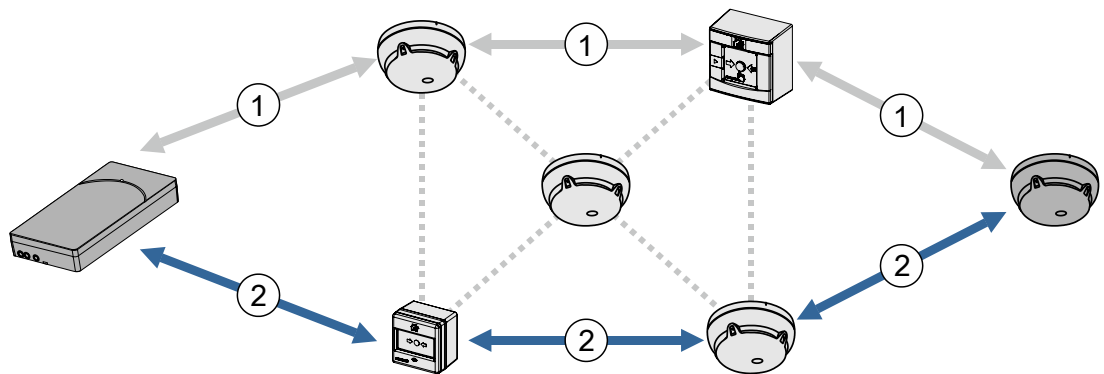

Multihop technology

Multihop technology makes it possible to extend the range in line with the number of hops. The radio link between one radio device and the next is referred to as a hop.

Characteristics:

- Each radio device has hop characteristics.
- A radio connection between a radio gateway and a radio device must take place over a maximum of three hops.

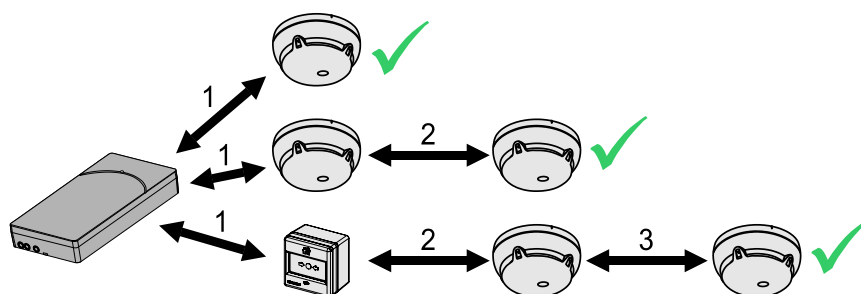

Use

- Consider the range between radio gateway and radio devices.
- The building structure can have a significant effect on the radio range (materials such as steel, concrete, lime sand brick, wood, etc.). Mesh technology provides a means of bypassing difficult points with up to two intermediate stations.
- Up to 16 radio gateways can be operated with radio cell overlapping.
- The radio gateway must be easily accessible for the service staff.

Limitations

The range can be restricted in rooms with a high level of transmission field damping, such as those with a framework of metal bars used as a partition or with metallic storage racks.

Power supply

The neural radio fire detector FDOOT271, the radio manual call points FDM273 and FDM275 and the radio gateway FDCW241 are supplied with power by the battery pack BAT3.6-10. The same type of battery can be used for each device.

The batteries have a service life of at least three years in normal operation. Thanks to battery monitoring, a backup battery can be connected to achieve a remaining life of at least six years.

Disposal



The device is considered an electronic device for disposal in accordance with the European Guidelines and may not be disposed of as domestic garbage.

- Dispose of the device through channels provided for this purpose.
- Comply with all local and currently applicable laws and regulations.
- Dispose of empty batteries in designated collection points.

Technical data

General (irrespective of the device)	
Max. number of overlapping radio cells in each location	16
Number of radio devices per radio cell	Max. 30 + radio gateway + line separator in radio gateway
Connection factor	2 + number of radio detectors
Sending/receiving antennas	Dual band antenna
Radio frequencies	<ul style="list-style-type: none"> • 433.05...434.79 MHz band 44b and 45b ¹ • 868...870 MHz band 48, 49, 50, 54b, and 56 ¹
Number of channels	<ul style="list-style-type: none"> • 868...870 MHz band: 27 • 433.05...434.79 MHz band: 20
Channel grid	50 kHz
Transmitting power dependent on sub-band:	<ul style="list-style-type: none"> • ≤10 mW ERP in band 44b, 45b, and 49 ¹ • Typ. 10 (max. ≤25) mW ERP in band 48, 50, 54b, and 56b ¹
Range	<ul style="list-style-type: none"> • Indoors: Max. 180 m • Outdoors: Max. 1000 m
Supply	Battery pack BAT3.6-10 (to be ordered separately)

¹ 2013/752/EU: according Official Journal of the European Union, COMMISSION IMPLEMENTING DECISION of 11 December 2013 amending Decision 2006/771/EC on harmonisation of the radio spectrum for use by short-range devices and repealing Decision 2005/928/EC (notified under document C(2013) 8776) (Text with EEA relevance)

	FDCW241	FDOOT271
Communication protocol (detector line)	FDnet/C-NET	–
Electromagnetic compatibility	100 kHz...2.5 GHz: 30 V/m	100 kHz...2.5 GHz: 30 V/m
Permissible wind speed	–	Max. 5 m/s
Compatible conductor cross-sections at the connection terminals	0.2...1.5 mm ²	–
Battery service life	>6 years	>3 years
MC link interface	3.5 mm jack socket	–
Operating temperature	-10...+55 °C	-10...+55 °C
Storage temperature	-30...+75 °C	-30...+75 °C
Air humidity (no moisture condensation)	≤95 % rel.	≤95 % rel.
Protection category (IEC 60529)	<ul style="list-style-type: none"> • IP40 • IP65 with housing FDCH221 	IP44
Color	~RAL 9010 pure white	~RAL 9010 pure white
Dimensions	89 x 167 x 28	Ø 117 x 64 with FDB271
Standards ¹	EN 54-17, EN 54-18, EN 54-25	EN 54-5, EN 54-7, EN 54-25
Approvals	VdS: G212103	VdS: G212104

	FDM273	FDM275	FDM275(F)
Electromagnetic compatibility	<ul style="list-style-type: none"> • 10 kHz...100 kHz: 160 V/m • 100 kHz...2.5 GHz: 30 V/m 	<ul style="list-style-type: none"> • 10 kHz...100 kHz: 160 V/m • 100 kHz...2.5 GHz: 30 V/m 	<ul style="list-style-type: none"> • 10 kHz...100 kHz: 160 V/m • 100 kHz...2.5 GHz: 30 V/m
Battery service life	>3 years	>3 years	>3 years
Operating temperature	-10...+55 °C	-10...+55 °C	-10...+55 °C
Storage temperature	-30...+75 °C	-30...+75 °C	-30...+75 °C
Air humidity (no moisture condensation)	≤95 % rel.	≤95 % rel.	≤95 % rel.
Protection category (IEC 60529)	IP44	IP24D	IP24D
Color	~RAL 3000 flame red	~RAL 3000 flame red	~RAL 3000 flame red
Dimensions	135 x 135 x 58	87 x 87 x 63	87 x 87 x 63
Standards ¹	EN 54-11 (type B indoors) EN 54-25	EN 54-11 (type A indoors) EN 54-25	EN 54-11 (type A indoors) EN 54-25
Approvals	VdS: G213092	VdS: G216092	VdS: G216092

¹ You will find more information about standards in the information about CE marking below

Dimensional drawings

Radio gateway FDCW241

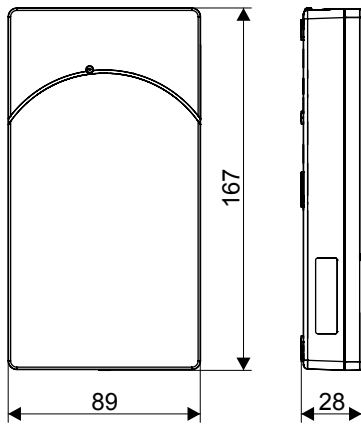

Neural radio fire detector FDOOT271 with detector base FDB271

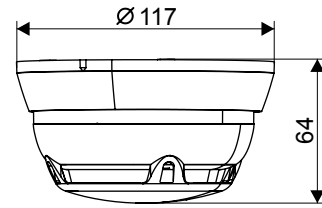

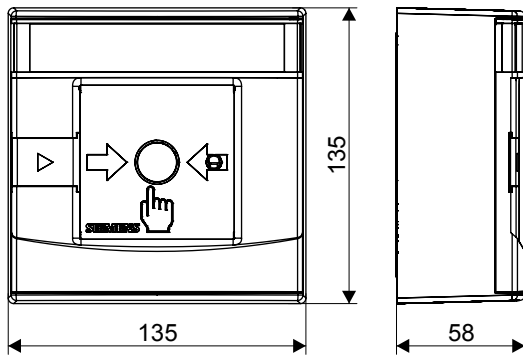

Radio manual call point FDM273



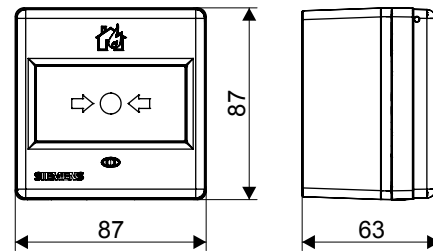

Radio manual call points FDM275 and FDM275(F)



12		0786	FDCW241	Siemens Schweiz AG; Theilerstrasse 1a CH-6300 Zug Technical data: see doc. A6V10227639
FDCW241 - Input/output device incl. short-circuit isolator for use in fire detection and fire alarm systems installed in buildings.				
305/2011/EU (CPR): EN 54-18 / EN 54-17 / EN 54-25 ; 2011/65/EU (RoHS): EN 50581 ; 2014/53/EU (RED): EN 300 220-2 / EN 300 220-3-2 / EN 301 489-3 / EN 62479 / EN 60950-1				
The declared performance and conformity can be seen in the Declaration of Performance (DoP) and the EU Declaration of Conformity (DoC), which is obtainable via the Customer Support Center: Tel. +49 89 9221-8000 or https://siemens.com/bt/download				
DoP No.: 0786-CPR-21168; DoC No.: CED-FDCW241				

12		0786	FDOOT271	Siemens Schweiz AG; Theilerstrasse 1a CH-6300 Zug Technical data: see doc. A6V10227635
FDOOT271 - Smoke/heat detector using radio link for use in fire detection and fire alarm systems installed in buildings.				
305/2011/EU (CPR): EN 54-5 / EN 54-7 / EN 54-25 ; 2011/65/EU (RoHS): EN 50581 ; 2014/53/EU (RED): EN 300 220-2 / EN 301 220-3-2 / EN 301 489-3 / EN 62479 / EN 60950-1				
The declared performance and conformity can be seen in the Declaration of Performance (DoP) and the EU Declaration of Conformity (DoC), which is obtainable via the Customer Support Center: Tel. +49 89 9221-8000 or https://siemens.com/bt/download				
DoP No.: 0786-CPR-21169; DoC No.: CED-FDOOT271				

14		0786	FDM273	Siemens Schweiz AG; Theilerstrasse 1a CH-6300 Zug Technical data: see doc. A6V10347733
FDM273 - Manual callpoint using radio link for use in fire detection and fire alarm systems installed in buildings.				
305/2011/EU (CPR): EN 54-11 / EN 54-25 ; 2014/53/EU (RED): EN 300 220-2 / EN 300 220-3-2 / EN 301 489-3 / EN 62479 / EN 60950-1 ; 2011/65/EU (RoHS): EN 50581				
The declared performance and conformity can be seen in the Declaration of Performance (DoP) and the EU Declaration of Conformity (DoC), which is obtainable via the Customer Support Center: Tel. +49 89 9221-8000 or https://siemens.com/bt/download				
DoP No.: 0786-CPR-21306; DoC No.: CED-FDM273				

16		0786	FDM275, FDM275(F)	Siemens Schweiz AG; Theilerstrasse 1a CH-6300 Zug Technical data: see doc. A6V10401120
FDM275, FDM275(F) - Manual callpoint using radio link for use in fire detection and fire alarm systems installed in buildings.				
305/2011/EU (CPR): EN 54-11 / EN 54-25 ; 2014/53/EU (RED): EN 300 220-2 / EN 300 220-3-2 / EN 301 489-3 / EN 62479 / EN 60950-1 ; 2011/65/EU (RoHS): EN 50581				
The declared performance and conformity can be seen in the Declaration of Performance (DoP) and the EU Declaration of Conformity (DoC), which is obtainable via the Customer Support Center: Tel. +49 89 9221-8000 or https://siemens.com/bt/download				
DoP No.: 0786-CPR-21526; DoC No.: CED-FDM275, FDM275(F)				